

# ➤ Instructions

## Thule Motion XT

6292 6295 6296 6297 6298 6299

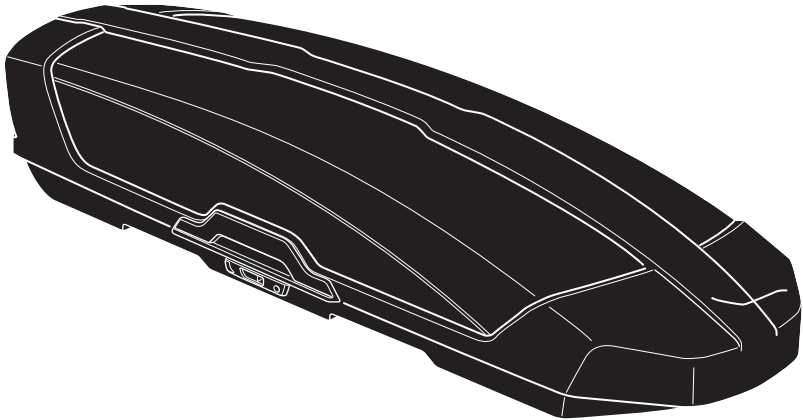

- EN** Roof box for roof-mounted racks  
**DE** Dachbox für Dachträger  
**FR** Coffre pour barres de toit  
**NL** Dakkoffer  
**IT** Box da tetto per portapacchi da installare sul tetto  
**ES** Cofre portaequipajes para barras de techo  
**PT** Caixa bagageira para barras de tejadilho  
**SV** Takbox för takmonterade räckor  
**DK** Tagboks til tagbjælter  
**NO** Takboks til takmonterte stativer  
**FI** Katolle asennettaviin telineisiin sopiva kuljetuslaatikko  
**ET** Katusele paigaldatav katuseboks  
**LV** Jumta kaste uz jumta uzstādāmiem bagāžniekiem  
**LT** Ant stogo tvirtinamų skersinių bagažinės  
**PL** Box dachowy na bagażnik montowany na dachu  
**RU** Грузовой бокс на крышу автомобиля  
**UK** Вантажний бокс для багажників для даху  
**BG** Кутия за багаж за релси, монтирани върху покрива  
**CS** Střešní box pro montáž na střechu  
**SK** Strešný box na strešné nosiče
- SL** Strešni kovček za strešne prtljažnike  
**HR/BIH** Krovna kutija za krovne nosače  
**RO** Portbagaj de acoperiș pentru cadru de bare montate pe acoperiș  
**HU** Tetőre szerelhető tetőbox  
**EL** Μπαγκάζιέρα οροφής για μπάρες οροφής  
**TR** Araç üstüne bağlanan raflar için tavan kutusu
- HE** תא חפצים ללגג הרכב  
**AR** صندوق سقف للحوامل المثبتة على السقف
- ZH** 用于车顶架的车顶箱  
**JA** ルーフマウント型ラック用ルーフボックス  
**KO** 루프 장착 랙 루프 박스  
**TH** กล่องบนหลังคาสำหรับแร็คหลังคา



**CITY CRASH**  
Complies with ISO norm

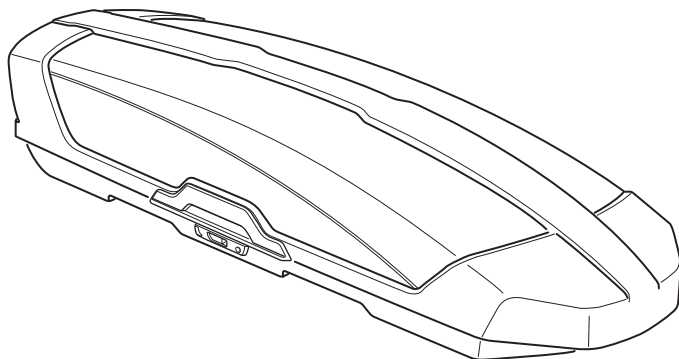
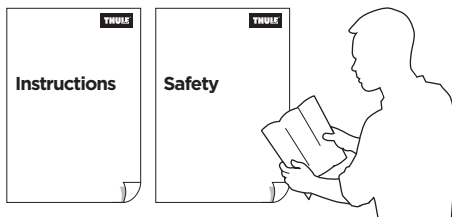

x1



x1



x3



x2

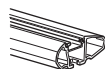

Thule WingBar Evo

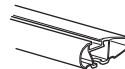

Thule WingBar

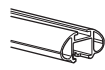

Thule AeroBar



Thule SlideBar



Thule Squarebar

**i**

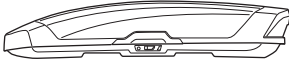
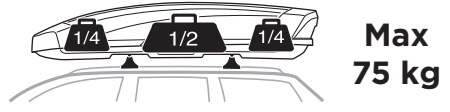

|        |         |
|--------|---------|
| Sport  | 16 kg   |
| M      | 17,5 kg |
| L      | 20 kg   |
| XL     | 23,5 kg |
| XXL    | 25,5 kg |
| Alpine | 25,5 kg |

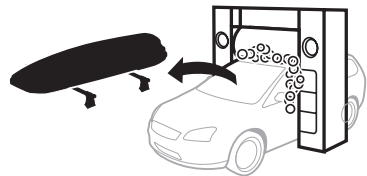
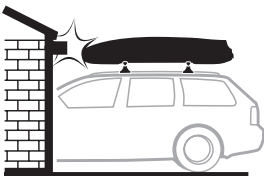
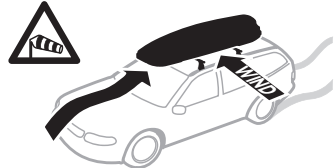
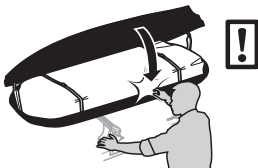
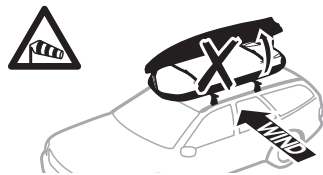
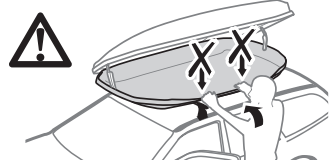
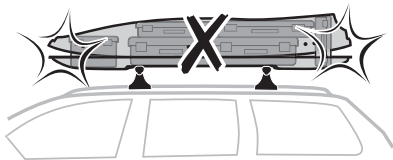
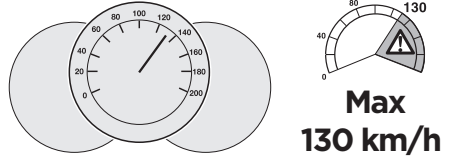

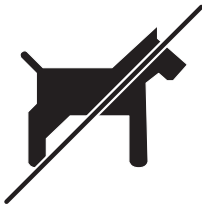
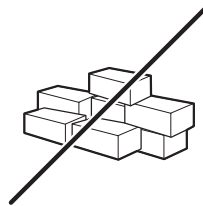
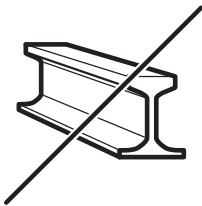
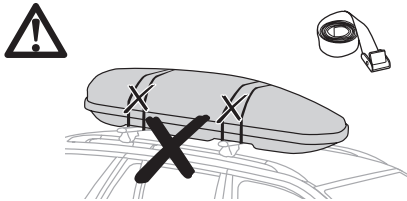
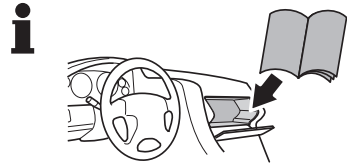
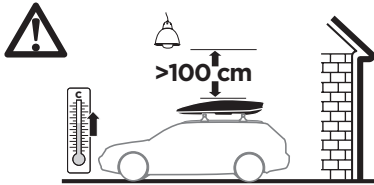
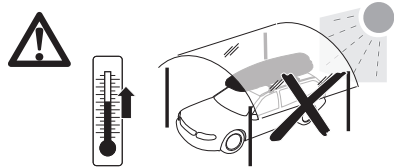
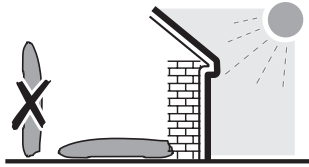



# Thule T-track Adapter

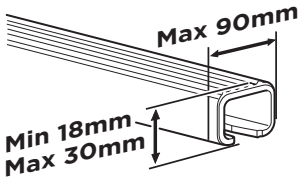

696600

697600

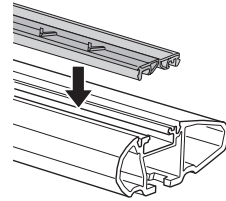
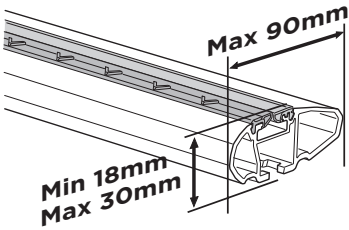
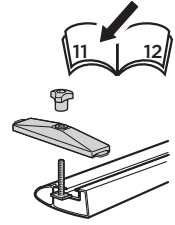

|        | D Min* | D Max* | W in* | W out* | H*  | R Min* |
|--------|--------|--------|-------|--------|-----|--------|
| M      | 560    | 930    | 755   | 865    | 460 | 1198   |
| Sport  | 560    | 930    | 565   | 675    | 430 | 1250   |
| L      | 560    | 930    | 785   | 895    | 440 | 1290   |
| XL     | 560    | 930    | 805   | 915    | 440 | 1347   |
| XXL    | 560    | 930    | 840   | 950    | 470 | 1440   |
| Alpine | 560    | 930    | 840   | 950    | 350 | 1417   |

\*mm

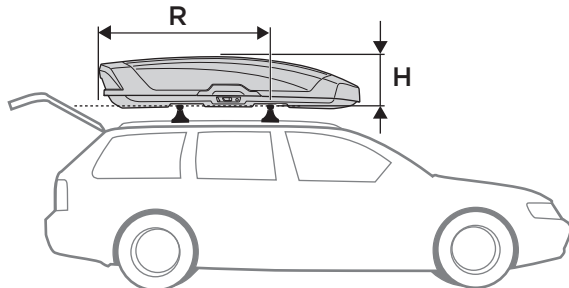
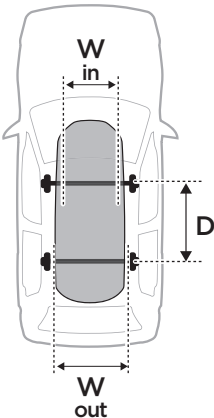

1

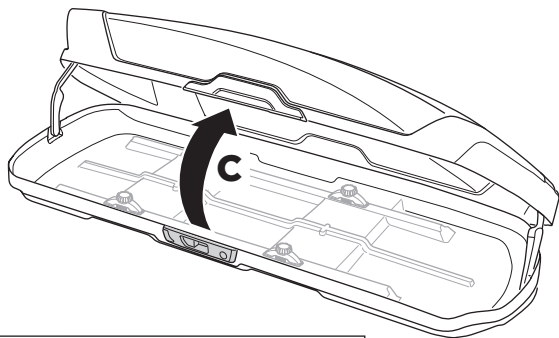
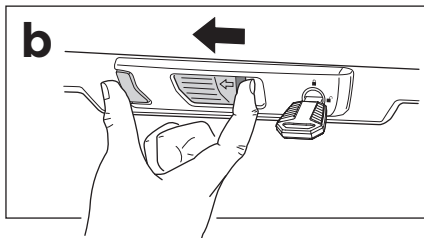
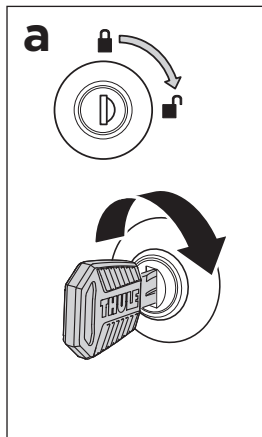

2

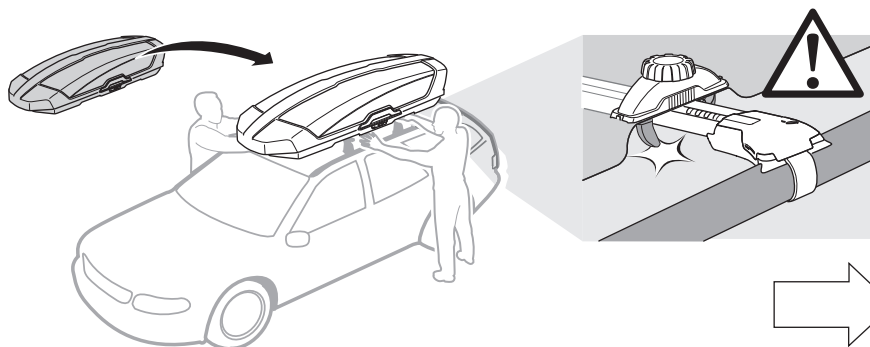
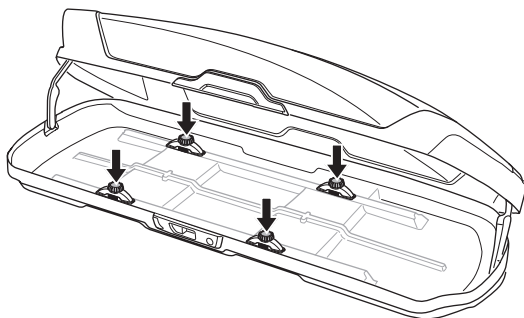
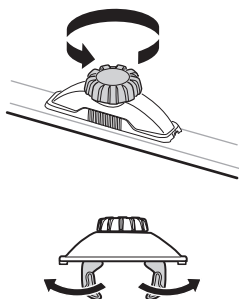

3

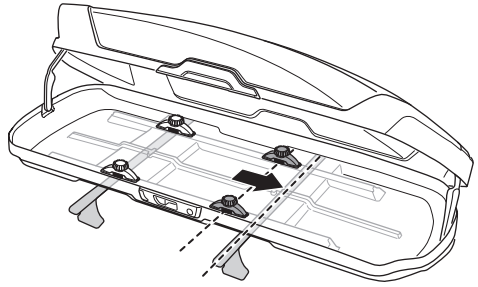
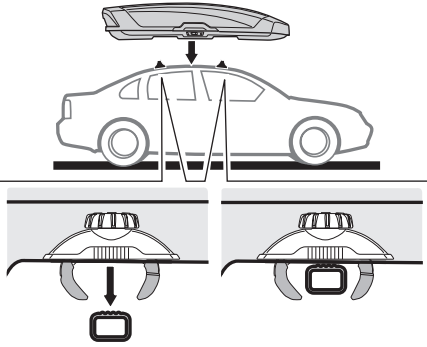
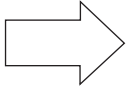

4

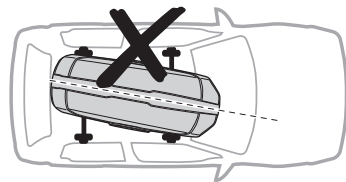
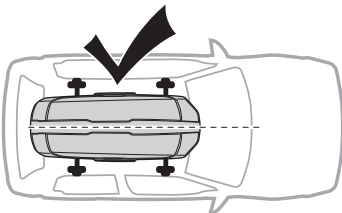
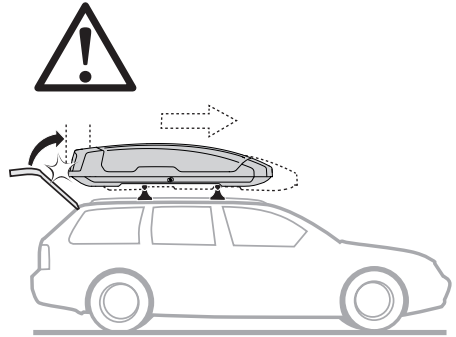
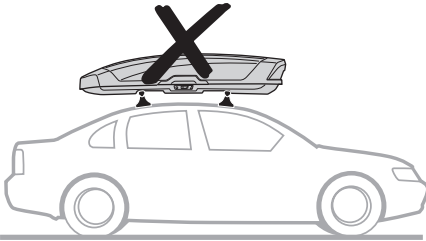

5

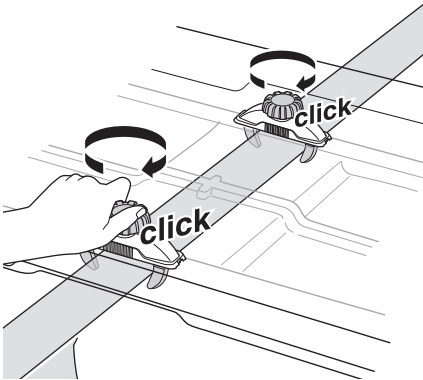
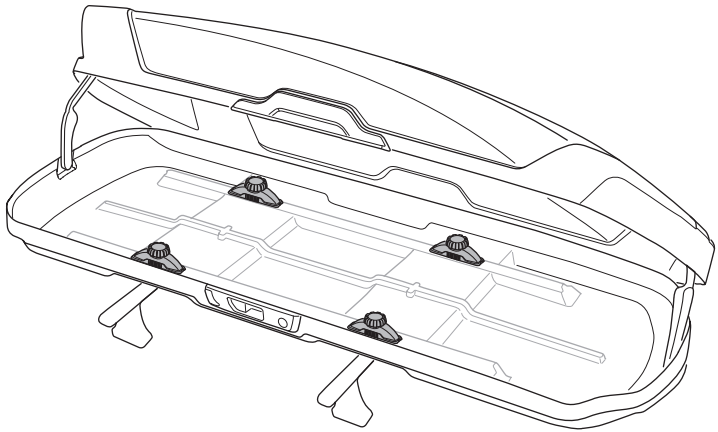

**i**

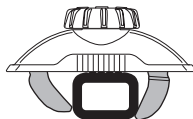
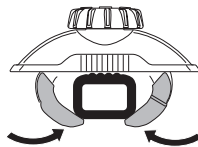
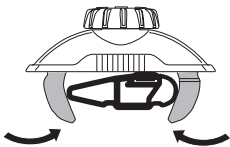
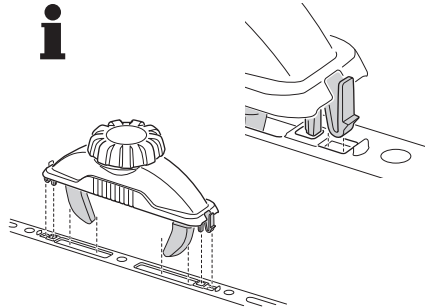



6



x 3

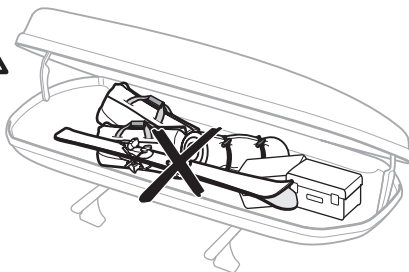
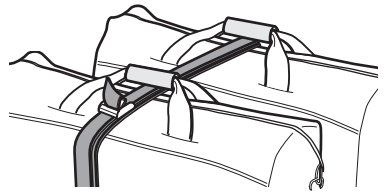
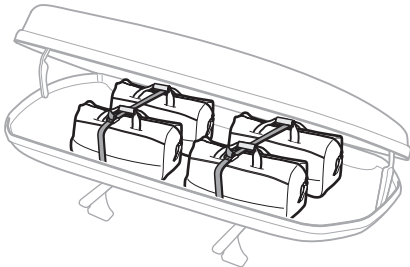
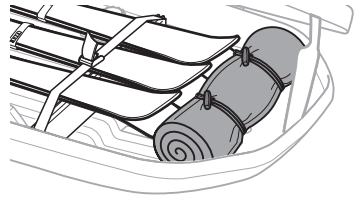
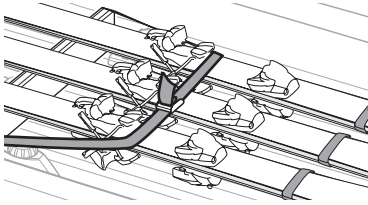
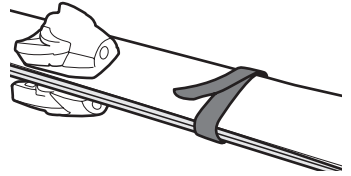
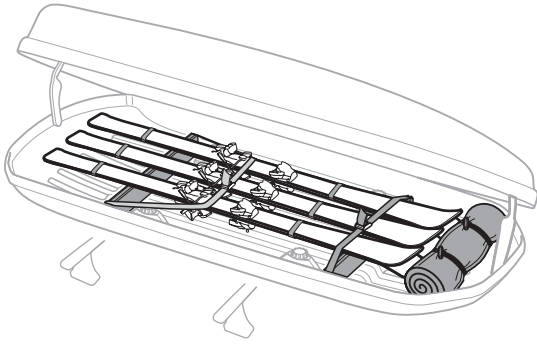
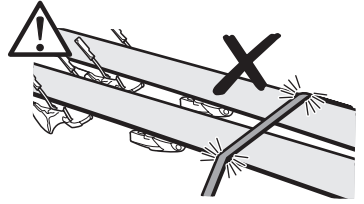
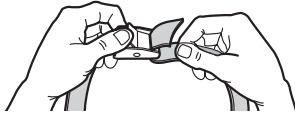

7

a

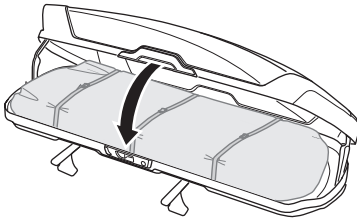

b

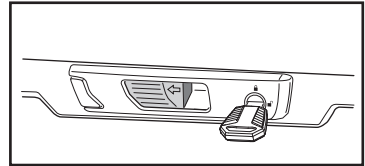
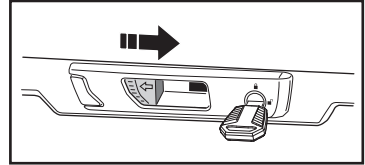
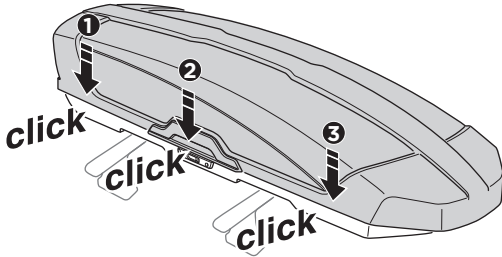

c

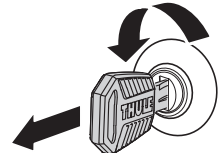
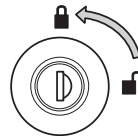
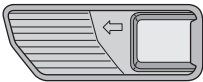
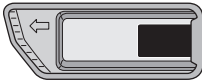

8

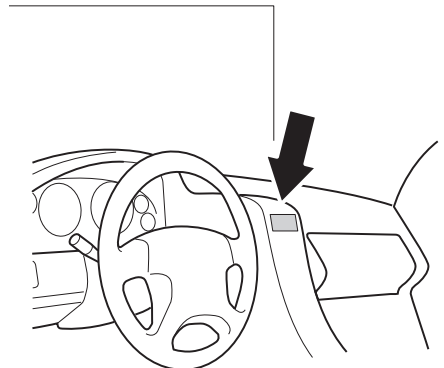
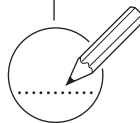
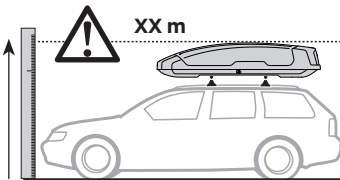
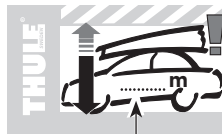

## Thule T-track Adapter

**696600** → 24x30 mm

**697600** → 20x27 mm

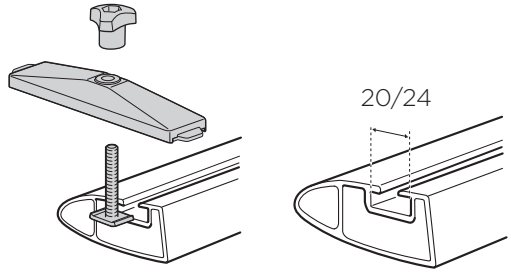

## Thule MultiLift

**572004**

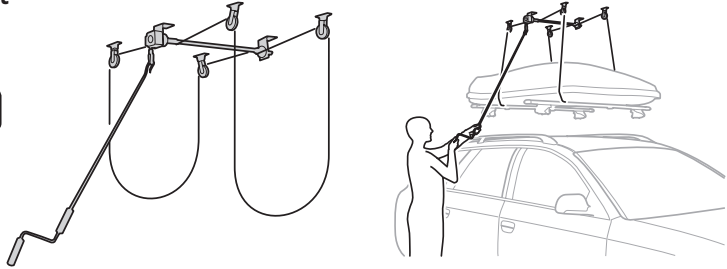

## Thule Box Ski Carrier Adapter

**694600** → Sport

**694800** → M/L

**694900** → XL/XXL/Alpine

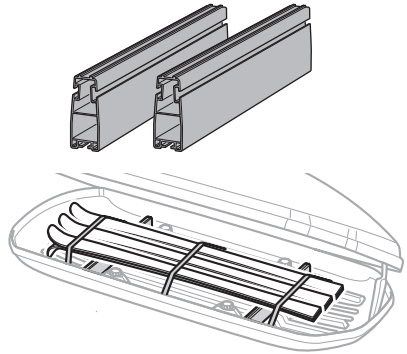

## Thule Box Lid Cover

**698100** → S/M/L

**698200** → Sport

**698400** → XL/XXL/Alpine

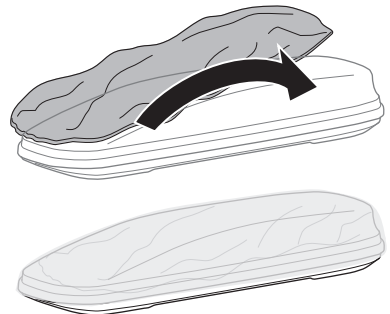

|                       |                         |                          |                        |
|-----------------------|-------------------------|--------------------------|------------------------|
| <b>EN</b> Accessories | <b>DK</b> Tilbehør      | <b>UK</b> Аксессуары     | <b>EL</b> Εξαρτήματα   |
| <b>DE</b> Zubehör     | <b>NE</b> Tilbehør      | <b>BG</b> Принадлежности | <b>TR</b> Aksesuarlar  |
| <b>FR</b> Accessoires | <b>FI</b> Lisävarusteet | <b>CS</b> Doplňky        | <b>AR</b> الملحقات     |
| <b>NL</b> Accessoires | <b>ET</b> Lisavarustus  | <b>SK</b> Príslušenstvo  | <b>HE</b> אביזרים      |
| <b>IT</b> Accessori   | <b>LV</b> Piederumi     | <b>SL</b> Dodatki        | <b>ZH</b> 附件           |
| <b>ES</b> Accesorios  | <b>LT</b> Priedai       | <b>HR/BiH</b> Dodaci     | <b>JA</b> アクセサリー       |
| <b>PT</b> Acessórios  | <b>PL</b> Akcesoria     | <b>RO</b> Accesorii      | <b>KO</b> 액세서리         |
| <b>SV</b> Tillbehör   | <b>RU</b> Аксессуары    | <b>HU</b> Tartozékok     | <b>TH</b> อุปกรณ์เสริม |

## Thule One-Key System

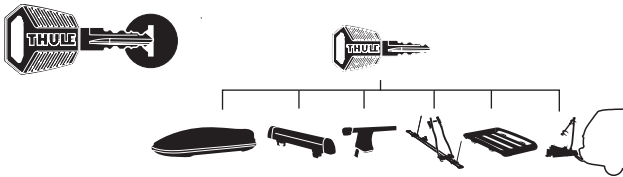

- 450400** (x4)
- 450600** (x6)
- 450800** (x8)
- 451200** (x12)
- 451600** (x16)

